

Color sensors

FKDM 22N1901/S14F

dimension drawing

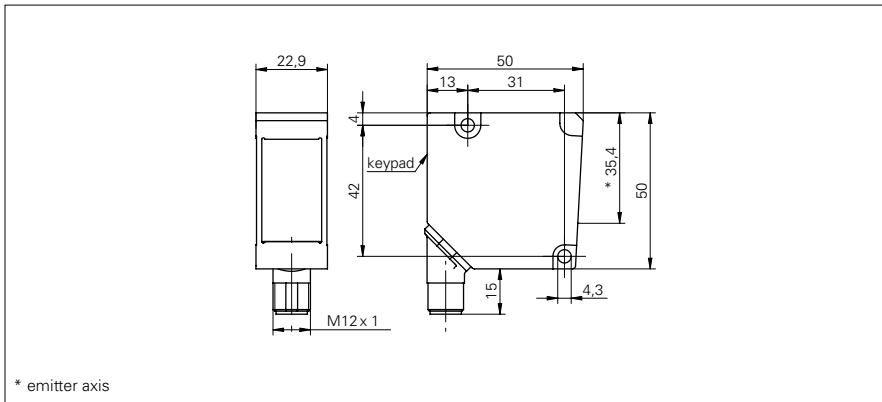

general data

sensing distance Tw	40 mm
sensor channels	4 (teachable)
tolerance ranges	5-step teachable (LEDs)
size of measuring spot	3 mm x 5 mm
light source	LED red / green / blue
signal display (Teach)	LED orange
channel status display	LED yellow per channel
power on indication	LED green

electrical data

response time / release time	< 0,34 ms
voltage supply range +Vs	10 ... 30 VDC
power consumption	< 2 W
output circuit	NPN
output function	light operate
voltage drop Vd	< 1,8 VDC
output current (per channel)	< 100 mA
remote Teach-In input	protocol with return signal through channel 1-output
sync. input	high active
level (sync., teach)	high: 2/3 Vs...Vs low: 0 V...1/3 Vs
short circuit protection	yes
reverse polarity protection	yes

mechanical data

width / diameter	22,9 mm
type	rectangular
housing material	die-cast zinc
front (optics)	glass
device plug	connector M12, 8 pin, rotatable

ambient conditions

operating temperature	-10 ... +55 °C
protection class	IP 67

photo



connection diagram

